

南京诺金电气有限公司

Nanjing Nowking Electric Co., Ltd

电源插头防尘盖样本



产品名称：电源插头防尘盖

规格型号：LPCG-1

◆ MATERIAL: PE

◆ COLOR: NATURAL

◆ UNIT: mm

用途：保护电源插头，防氧化。

LPCG-1 结构图

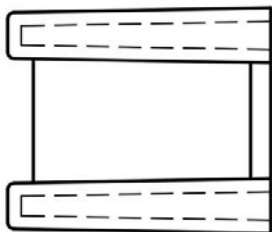
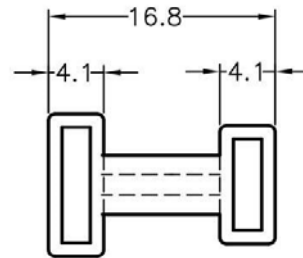
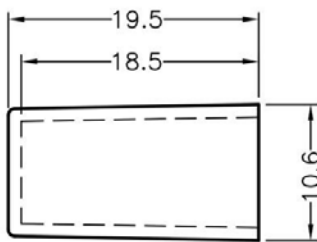

	PART NO	PACKAGE
	LPCG-1	250

总机/TEL: +86 25 85422485 85437901
传真/FAX: +86 25 85420612
<http://www.nowking.com> E-mail: nk@nowking.com
QQ: 260678075

南京诺金电气有限公司

Nanjing Nowking Electric Co., Ltd

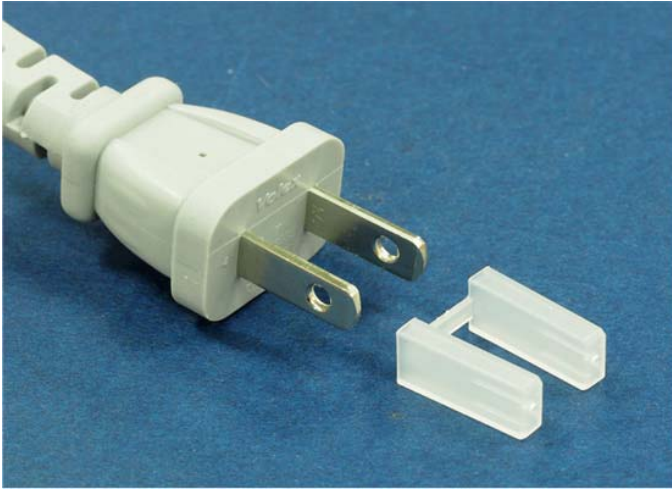

产品名称：电源插头防尘盖

规格型号：LPCG-2

- ◆ MATERIAL: PP
- ◆ COLOR: NATURAL
- ◆ UNIT: mm

用途：保护电源插头，防氧化。

LPCG-2 结构图

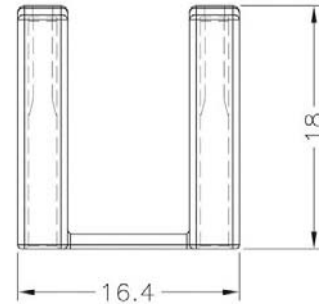
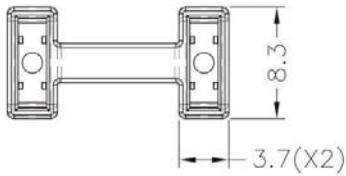

	PART NO	PACKAGE
	LPCG-2	250

南京诺金电气有限公司

Nanjing Nowking Electric Co., Ltd



产品名称：电源插头防尘盖

规格型号：LPCG-3

- ◆ MATERIAL: PE
- ◆ COLOR: NATURAL
- ◆ UNIT: mm

用途：保护电源插头，电源插头防尘盖。

LPCG-3 结构图

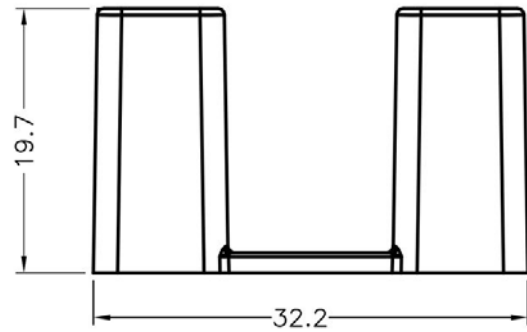
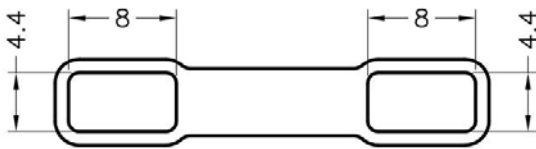

	PART NO	PACKAGE
	LPCG-3	1000

南京诺金电气有限公司

Nanjing Nowking Electric Co., Ltd



产品名称：电源插头防尘盖

规格型号：LPCG-4

- ◆ MATERIAL: PE
- ◆ COLOR: NATURAL
- ◆ UNIT: mm

用途：保护电源插头，电源插头防尘盖。

LPCG-4 结构图

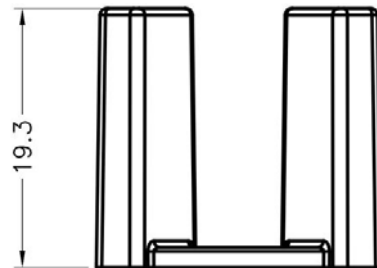
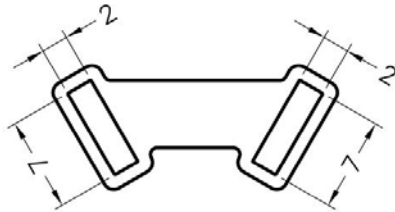

	PART NO	PACKAGE
	LPCG-4	1000

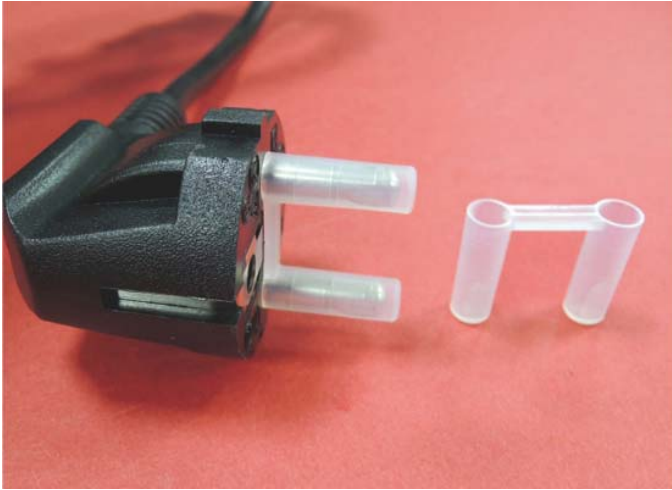

产品名称：电源插头防尘盖

规格型号：LPCG-5

- ◆ MATERIAL: PE
- ◆ COLOR: NATURAL
- ◆ UNIT: mm

用途：保护电源插头，电源插头防尘盖。

LPCG-5 结构图

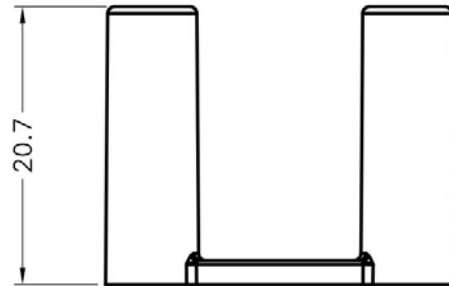
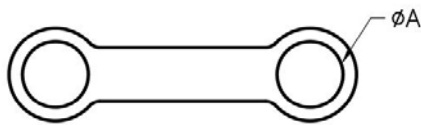

	PART NO	A	PACKAGE
	LPCG-5	4.9	1000

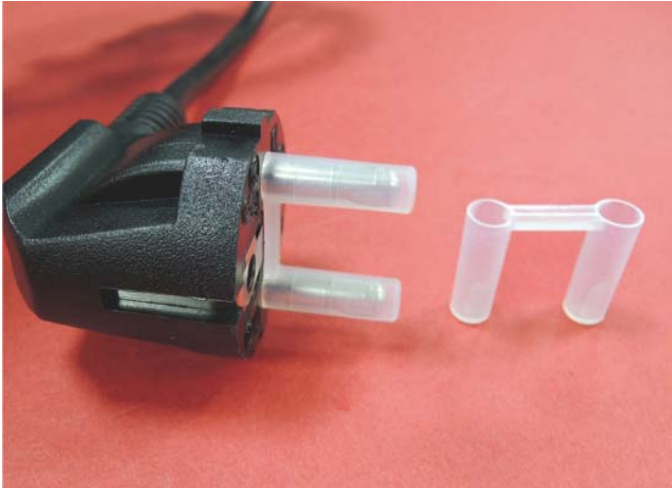

产品名称：电源插头防尘盖

规格型号：LPCG-6

- ◆ MATERIAL: PE
- ◆ COLOR: NATURAL
- ◆ UNIT: mm

用途：保护电源插头，电源插头防尘盖。

LPCG-6 结构图

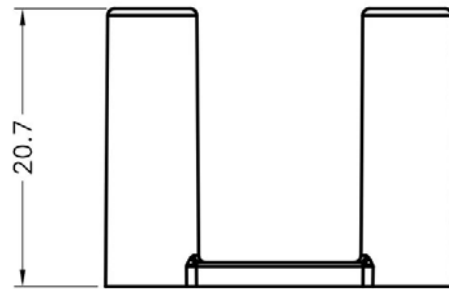
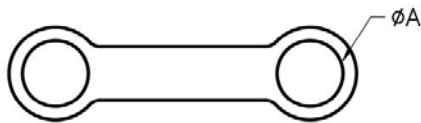

	PART NO	A	PACKAGE
	LPCG-6	4.1	1000